

## STANDARD MODELS

Model	Part Number	Frequency Range	Output Power $P_N$ min dBm	Gain min / typ dB	Noise Figure dB	Dimensions (L, W, H) mm	Weight kg
BLNA 0220-01N	10018880	20 MHz ... 2 GHz	+8	40 / 41 ±1	3,8	120 / 100 / 51	1.3



Dimensions without connectors  
Technical drawing(s) on next page(s)

## STANDARD SPECIFICATIONS

Input Impedance:	50 Ohm nominal
Output Impedance:	50 Ohm nominal
Load VSWR:	<2.5:1 typ.
Spurious:	-60 dBc min. (excluding harmonics)
Harmonics:	-20 dBc
Class of Operation:	A-linear

## GENERAL

RF Input:	N-f
RF Output:	N-f
Mains Supply:	230 V AC      47 ... 63 Hz
Power Consumption:	<10 W
Conformity:	CE (EN 55022, CISPR 22)
Ambient Temperature:	0 ... +40 °C
Storage Temperature:	-25 ... 85 °C
Relative Humidity:	up to 95% (non-condensing)
Operating Altitude:	up to 2000 m above sea level
Vibration and Shock:	MIL-STD-810 G

## REMARKS

K) Battery Operation

Dieses Dokument ist Eigentum der Firma Bonn Elektronik GmbH. Vervielfältigung und Veröffentlichung ohne ausdrückliche Genehmigung ist untersagt. Änderungen im Sinne des technischen Fortschritts können ohne Vorankündigungen vorgenommen werden. Wenn nichts anders angegeben alle Maße in Millimeter.

This document is the property of Bonn Elektronik GmbH. Reproduction and release without express permission is strictly prohibited. We reserve the right to introduce modifications without prior notification, where they serve technical progress. Unless otherwise indicated all dimensions in millimeters.

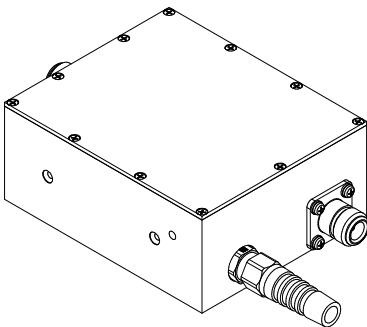
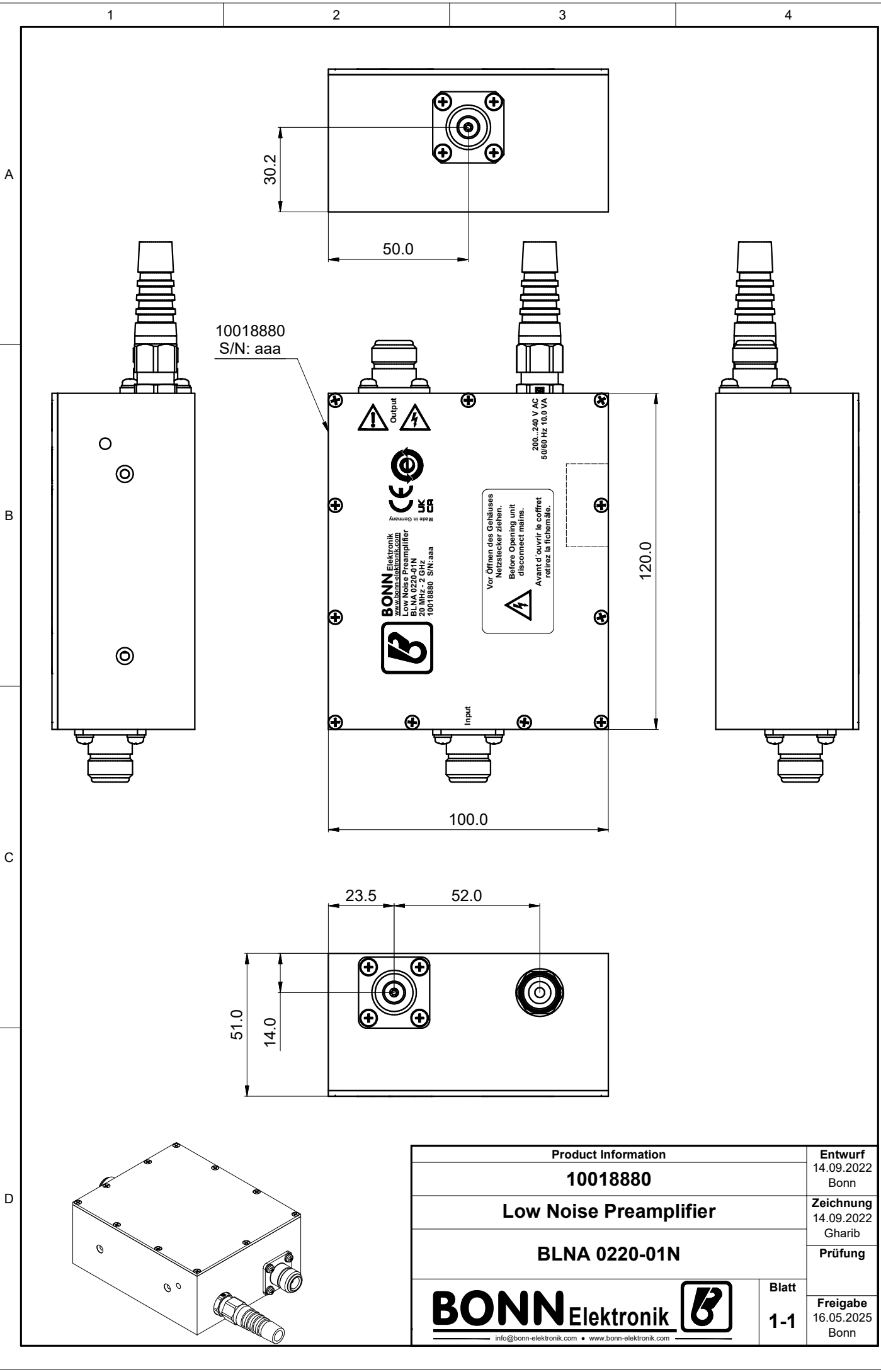

Product Information		Entwurf
10018880		14.09.2022 Bonn
Low Noise Pre-amplifier		Zeichnung
BLNA 0220-01N		14.09.2022 Gharib
BONN Elektronik 		Prüfung
Blatt		Freigabe
1-1		16.05.2025 Bonn